



DIAMANT-WERKZEUGE

in galvanischer Bindung

ausgewählte Beispiele

Vollstädt Diamant GmbH
Schlunkendorfer Str. 21





D-14554 Seddiner See

Tel.: 033205/746-30

Fax: 033205/ 746-31

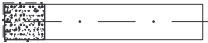
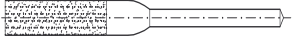
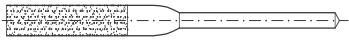
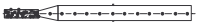
e-mail: werkzeuge@vdiamant.de

Internet: <http://www.vdiamant.de>

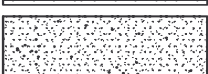
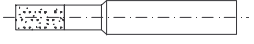
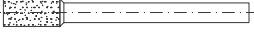
Diamant in galvanischer Bindung			
Trennscheiben 1A1R			
Hohlbohrer			
Feilen 140x70x3			
Feilen 180x70x5			
Schleifstifte-Set 3x45			
Schleifstifte-Set 6x60			
Schleifstifte-Set 6x45			
Gravierstifte			
Sägeblatt, Sägedraht			
Schleiffolie			
Schleifstifte 1A1W			
Schleifstifte 1A1W			

DIAMANT-TRENNSCHEIBEN

Form 1A1R
galvanisch gebunden

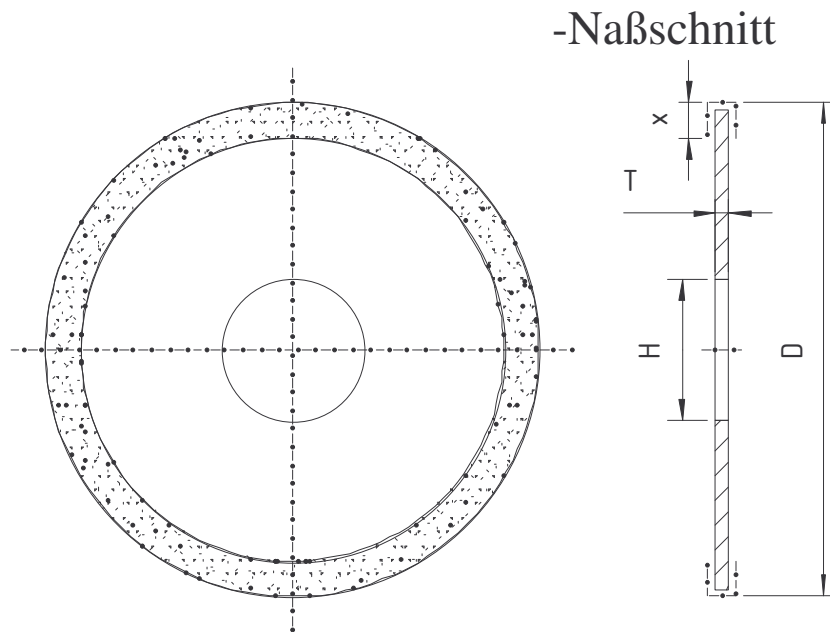

D	T	H	X	Körnung
20	0,2	2	2	D60/40
50	0,13; 0,5	16	1,5	D60/40
75	0,2	16	1,5	D60/40
100	0,35; 0,5; 1,0	16	1,5	D126
150	0,5	32	2,5	D126
	1,0	32	5,0	D251
200	1,0; 2,0; 2,5	32	5,0	D251
250	1,5	32	2,5	D251
	2,0	32	5,0	D251

Ø 20 auch mit Schaft 2,3x42 und Schraube lieferbar

Maße in mm, andere Abmessungen bitte anfragen

Bestellbeispiel: Diamant-Trennscheibe 1A1R 200x1,0x32 D251 galv. Bindung

[Zurück](#)

DIAMANT-HOHLBOHRER

galvanisch gebunden

-Naßschnitt

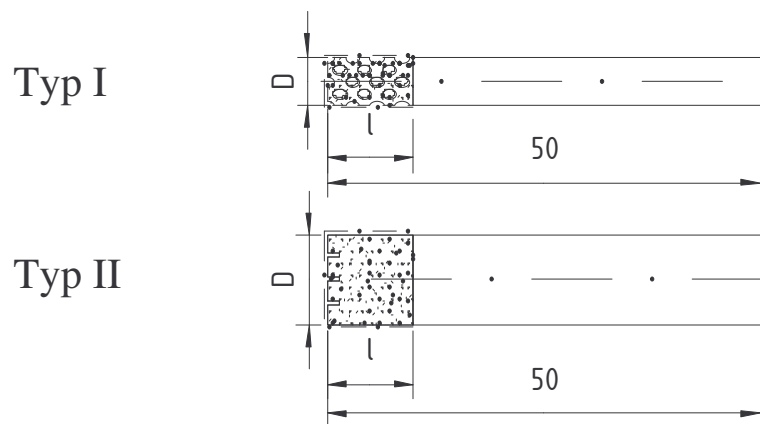

Typ	D	l
I	1,5	4
I	2,0	5
I	3,0	6
I	4,0	6
I	5,0	7
I	6,0	7
I	7,0	7
Set I	1,5-7,0	-
II	8,0	7
II	9,0	7
II	10,0	7
II	12,0	7
II	14,0	7

Maße in mm, andere Abmessungen bitte anfragen

Bestellbeispiel: Diamant-Hohlbohrer Ø2,0x5x50 galv. Bindung

[Zurück](#)

DIAMANT-NADELFEILEN 140x70x3 im Set (10 Stück)

galvanisch gebunden
D91

Flachstumpf		Oval	
Flachspitz		Vogelzunge	
Trapezspitz		Dreikant	
Rund		Barett	
Halbrund		Vierkant	

Form	Abmessungen	Durchmesser	Arbeitslänge	Gesamtlänge
Flachstumpf	5,4x1,2	3	70	140
Flachspitz	5,4x1,2	3	70	140
Trapezspitz	5,4x1,7x0,6	3	70	140
Rund	2,9	3	70	140
Halbrund	5,2x1,7	3	70	140
Oval	3,4x2,4	3	70	140
Vogelzunge	5,0x1,8	3	70	140
Dreikant	3,6	3	70	140
Barett	5,4x1,9	3	70	140
Vierkant	2,6x2,6	3	70	140

Maße in mm

Bestellbeispiel: Diamant-Nadelfeilen, Set 140x70x3 D91 galv. Bindung

[Zurück](#)

DIAMANT-NADELFEILEN 180x70x5

galvanisch gebunden
D126

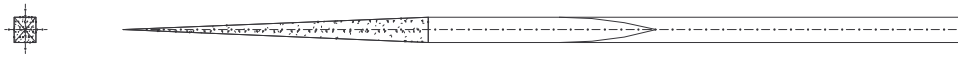

Form	Abmessungen	Durchmesser	Arbeitslänge	Gesamtlänge
Flachstumpf	9,2x2,0	5	70	180
Vierkantspitz	4,2x4,2	5	70	180

Maße in mm,
Bestellbeispiel: Diamant-Nadelfeile, flachstumpf 180x70x5 galv. Bindung

[Zurück](#)

DIAMANT-SCHLEIFSTIFTE 3,0 oder 2,3 x 45 mm im Set

galvanisch gebunden
D91

20 verschiedene Formen

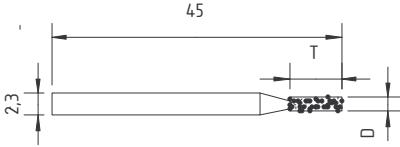
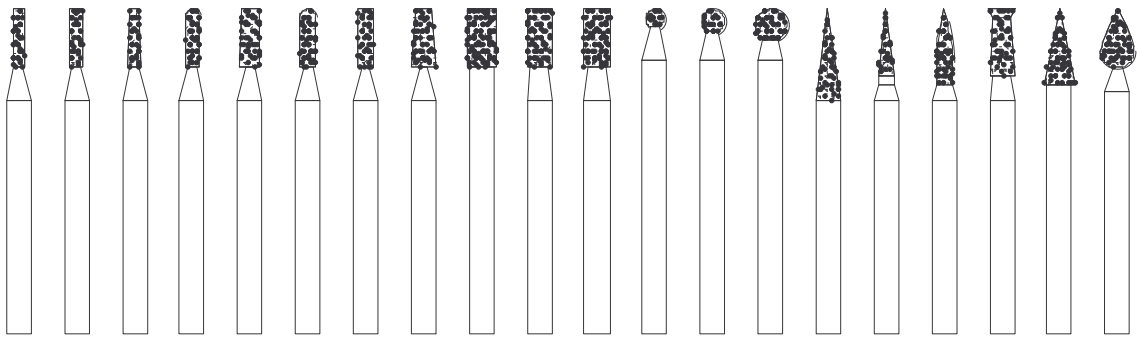
																				
																				
Typ	PM 01	PM 02	PM 03	PM 04	PM 05	PM 06	PM 07	PM 08	PM 09	PM 10	PM 11	PM 12	PM 13	PM 14	PM 15	PM 16	PM 17	PM 18	PM 19	PM 20
D	1,2	1,6	1,5	2,0	2,0	2,0	1,8	2,8	3,3	3,0	3,2	2,2	2,8	3,8	3,0	2,0	2,0	3,2	4,1	3,0
T	7,0	7,5	7,0	8,0	7,3	7,0	9,3	8,4	5,0	7,5	7,5	-	-	-	11	10	10	7,0	8,0	5,0

Maße in mm,

Bestellbeispiel: Diamant-Schleifstifte, Set 2,3x45 D91 galv. Bindung

[Zurück](#)

DIAMANT-SCHLEIFSTIFTE

6 x 60 mm im Set

galvanisch gebunden
D91

20 verschiedene Formen

Typ	PL01	PL02	PL03	PL04	PL05	PL06	PL07	PL08	PL09	PL10
D	8,4	9,4	7,7	10,1	10,3	8,5	7,6	10,1	10,0	6,0
T	20,0	20,0	16,0	15,0	19,3	19,5	15,0	20,0	15,8	23,5

Typ	PL11	PL12	PL13	PL14	PL15	PL16	PL17	PL18	PL19	PL20
D	10,0	10,0	10,5	10,0	8,0	8,2	6,4	9,4	6,4	6,3
T	19,5	3,5	105	-	-	20,1	10,0	2,2	11,5	6,5

Maße in mm,

Bestellbeispiel: Diamant-Schleifstifte, Set 6x60 D91 galv. Bindung

[Zurück](#)

DIAMANT-SCHLEIFSTIFTE

6 x 45 mm im Set

galvanisch gebunden
D126

10 verschiedene Formen

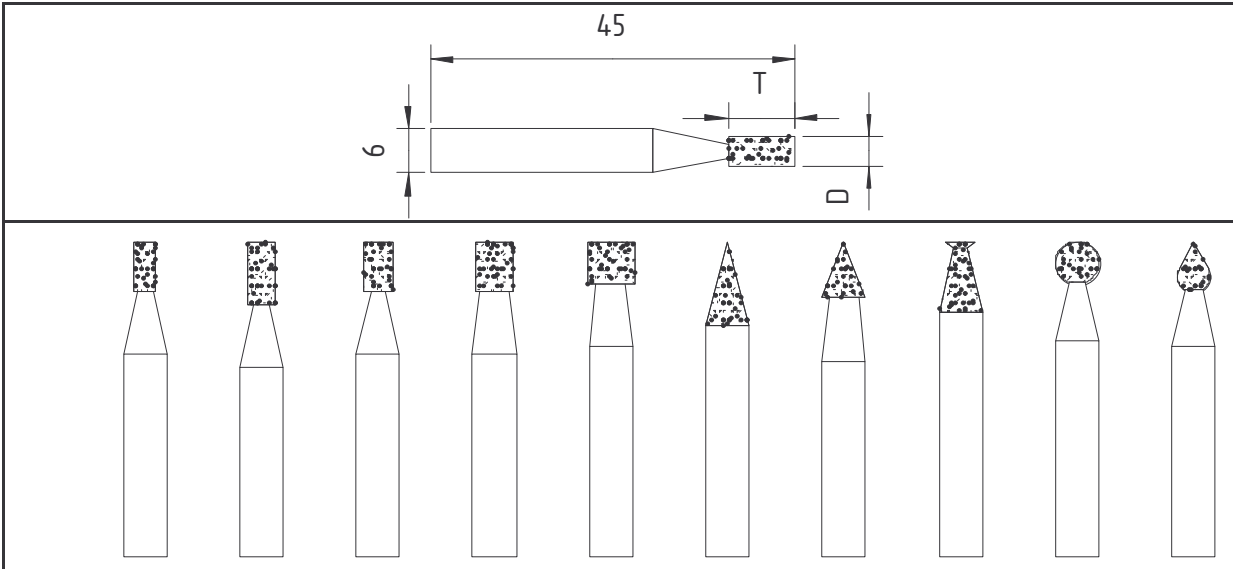

Typ	XW601	XW602	XW603	XW604	XW605	XW606	XW607	XW608	XW609	XW610
D	3,0	4,0	4,0	5,0	6,5	6,0	6,0	6,0	6,0	6,0
T	7,0	9,0	7,0	7,0	6,0	12,0	8,0	10,0	-	8,0

Maße in mm,

Bestellbeispiel: Diamant-Schleifstifte, Set 6x45 D126 galv. Bindung

[Zurück](#)

DIAMANT-GRAVIERSTIFTE

galvanisch gebunden

Abbildungen vergrößert

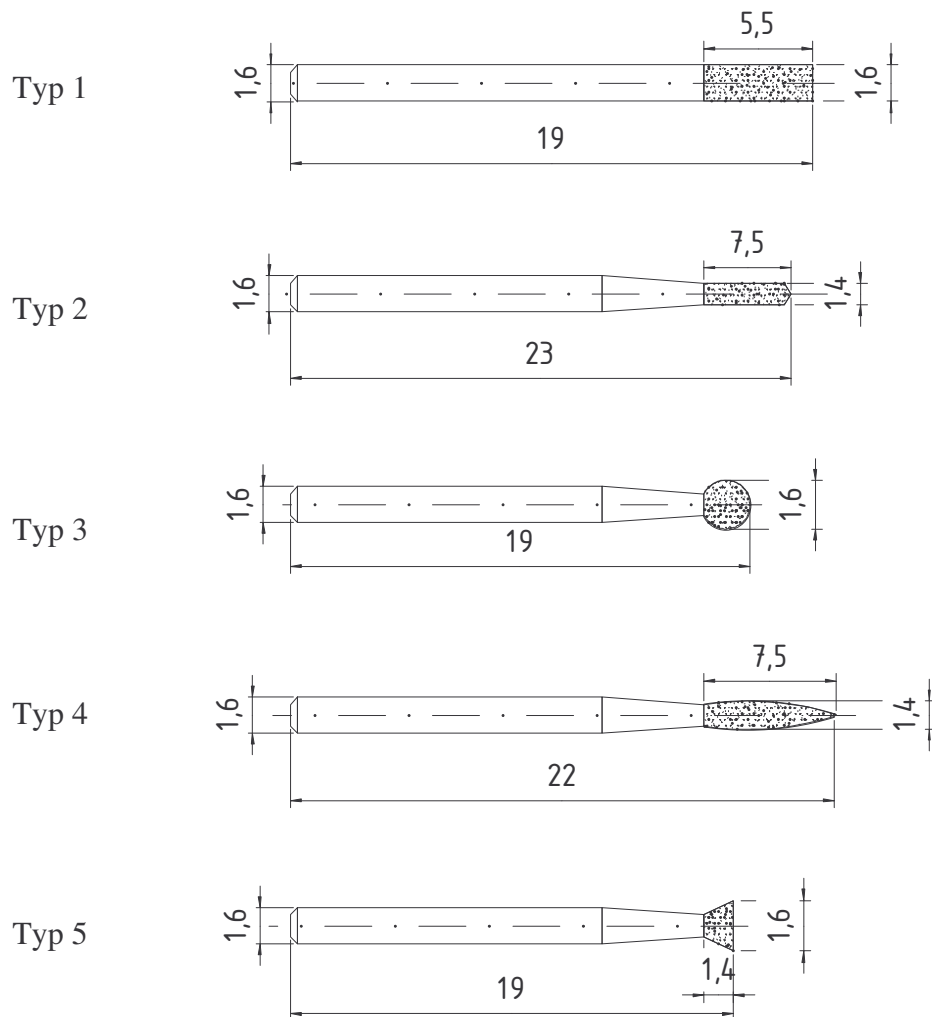

Maße in mm,

Bestellbeispiel: Diamant-Gravierstift Typ 3 galv. Bindung

[Zurück](#)

DIAMANT-SÄGEBLATT DIAMANT-BESCHICHTETER STAHLDRAHT

galvanisch gebunden
D126

zum Einspannen in eine Eisensäge

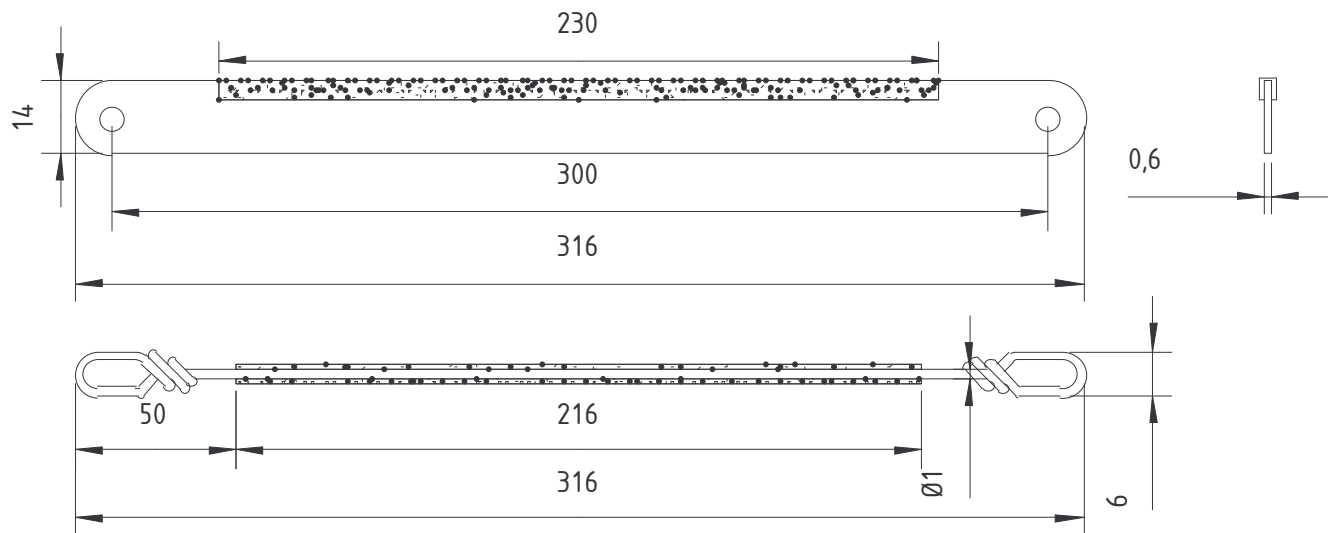

Maße in mm,

Bestellbeispiel: Diamant-Sägeblatt für Eisensäge galv. Bindung

[Zurück](#)

DIAMANT-SCHLEIFFOLIEN

galvanisch gebunden

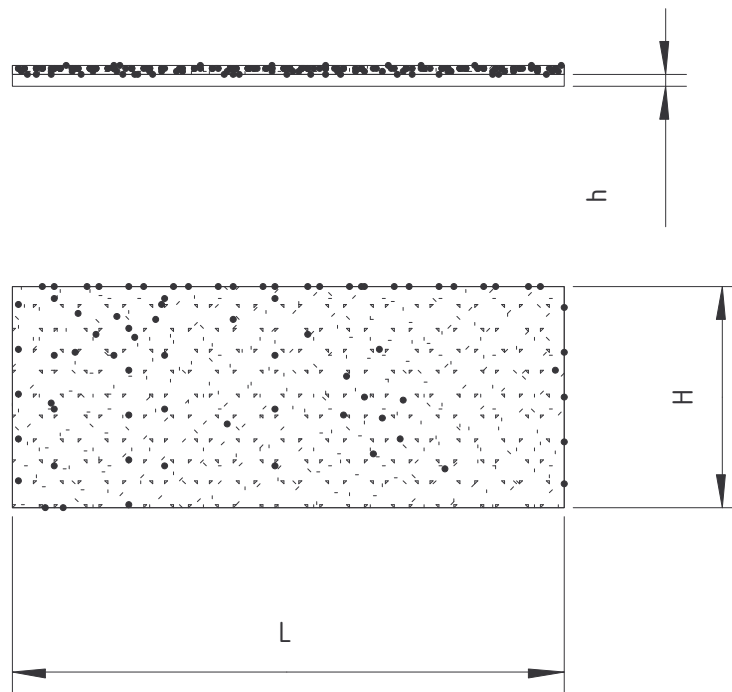

L	H	h	Körnungen µm
130	70	0,3	D28/20
500	100	0,3	D 64
	200	0,3	D107
1000	100	0,3	D126
	200	0,3	D151 D213

Maße in mm, andere Abmessungen oder Körnungen bitte anfragen

Bestellbeispiel: Diamant-Schleiffolie 130x70x0,3 D151 galv. Bindung

[Zurück](#)

DIAMANT-SCHLEIFSTIFTE

galvanisch gebunden
Körnung D46 bis D151

Typ 1A1W (AGZ)- Zylinder
Ausführung 1

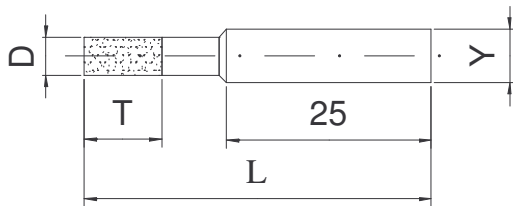

D	Y	T	L
0,5	3	3	40
0,7			
0,8			
1,0			
0,6	3	2	32
0,9	6	3	40
1,1			40; 60
4,2	3	5	40
1,3		10	
1,4			

D	Y	T	L	
1,5	3	10	40	
1,6				
1,8				
2,0				
1,5	6	4	60	
1,6		10		
1,8		4; 10		
2,0		4; 10		
2,2	3; 6	4	40	
2,4		6,4	60	
2,6	3	4; 6	40	
2,8				
3,0	6	4; 8	60	
3,2	4; 6	15	50	
3,4		4		
3,5	4	6	40	
4,0	6		4; 6; 15	60
4,5				
5,0		6; 8; 15		
5,6		15		

Maße in mm,

Bestellbeispiel: Diamant-Schleifstift 1A1W (AGZ) Ausführg.1 1,0x3x40x3 D91 galv.Bindung

[Zurück](#)

DIAMANT-SCHLEIFSTIFTE

galvanisch gebunden
Körnung D46 bis D151

Typ 1A1W (AGZ)- Zylinder
Ausführung 2

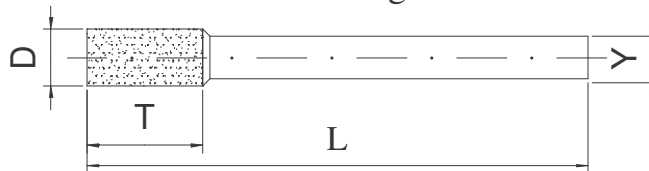

D	Y	T	L
3,5	3	4	40
4,0	3	4	40
	3	6	40
5,0	3	6	40
	3	8	40
	3	15	50
	4	6; 6; 15	50
6,0	3	6; 8	60
	6	6; 8	80
6,5	3	8; 10	60
	6	8; 10	80
7,5	4	8	60
9,0	6	10; 12	60
	8	10; 12	80
10,0	6	10	60
16,0	6	12; 20	60
20,0	8	12; 20	80

Maße in mm,

Bestellbeispiel: Diamant--Schleifstift 1A1W(AGZ) Ausführg.2 6,0x6x8x80 D91 galv.Bindung

[Zurück](#)

[Zurück](#)